

LIJIANI RD-908 Emergency Radio User Manual V1.05

Blue font indicates the changed content

MEET THE RD-908 EMERGENCY RADIO

Thank you for purchasing the LIJIANI RD-908 Emergency Radio. This radio has been designed with care to offer superior features. We urge you to read the manual to enjoy the many features of this radio. Buttons on the RD-908 serve various functions. The RD-908 was designed with as few buttons as possible, to enable ease of use and to ensure that the radio will be dust- and splashproof.

SETTING UP THE RADIO

Different countries and regions use different frequency bands. Before you start using the radio, you can select the band appropriate to your region. When the radio is OFF or in standby mode (the display is lit up), long press the BAND button. Use the up and down tuning buttons (number 2 in the diagram below) to select the correct frequency band for your region. The options are 87.5 for Asia and Europe (MW steps will be 9 kHz); 76.0 for Japan (MW 9 kHz steps); 64.0 for Russia (MW 9 kHz steps); and 87.0 for the United States (MW steps will be 10 kHz). The SW frequency band will remain the same for all regions (3.2 MHz to 30 MHz).

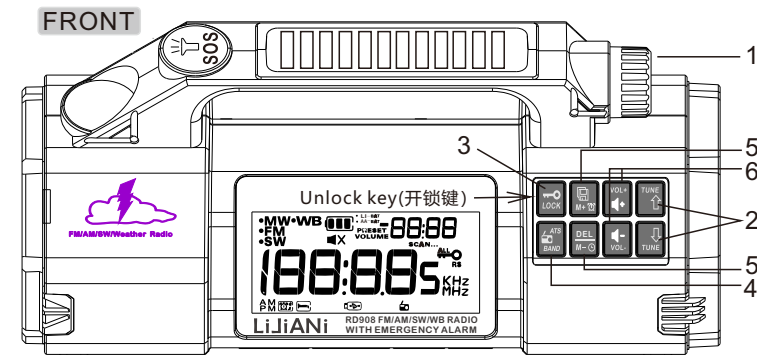

EXPLANATION OF BUTTONS AND FEATURES

1. ON/OFF and TUNING DIAL and SLEEP TIMER

Press the tuning dial once to turn the screen display on. Press again to turn on the radio. While the radio is ON, long press for three seconds to turn on the sleep timer. Once you see the sleep timer, press the tuning dial multiple times to select the correct time. You can select a sleep time in 10-minute intervals between 120 minutes and 10 minutes. To turn off the radio, press the tuning dial once. The display will remain lit for 10 seconds and then turn off, to save battery power. ①

2. TUNING

The RD-908 has two methods of manual tuning. You can either use the tuning dial or you can manually tune the radio using the tuning buttons. Pressing the tuning button once will jump to the next frequency. For MW, the step size is 9 kHz or 10 kHz, depending on how you have the radio set up. For FM, the step size is 10 kHz. For WB, the step size is 2.5 kHz. Pressing and holding either tuning button will automatically search for the next (previous) strong signal, either up or down in the current band.

2.1 Search for the next station (only in FM/AM/SW bands)

- ①: Long press the TUNE button and release to automatically search for the next radio station.
- ②: Rotate the wheel quickly and continuously to start searching for the next station. During the search, shaking the wheel again will stop searching for stations.
- ③: Press and hold the TUNE button (do not release) for 2 seconds to enter Quick Search. Continue to press and hold the TUNE button during the quick search. When the desired frequency is found, release the TUNE button.

2.2 NOAA ALERT

In the WB band, long press the ATS key to scan the weather alarm signal, when alarm signal enters, the radio will start the alarm and flash the backlight to alert us of a weather anomaly. Long Press ATS key again to end the weather alert function.

(For use in North America only, no information will be received elsewhere.)

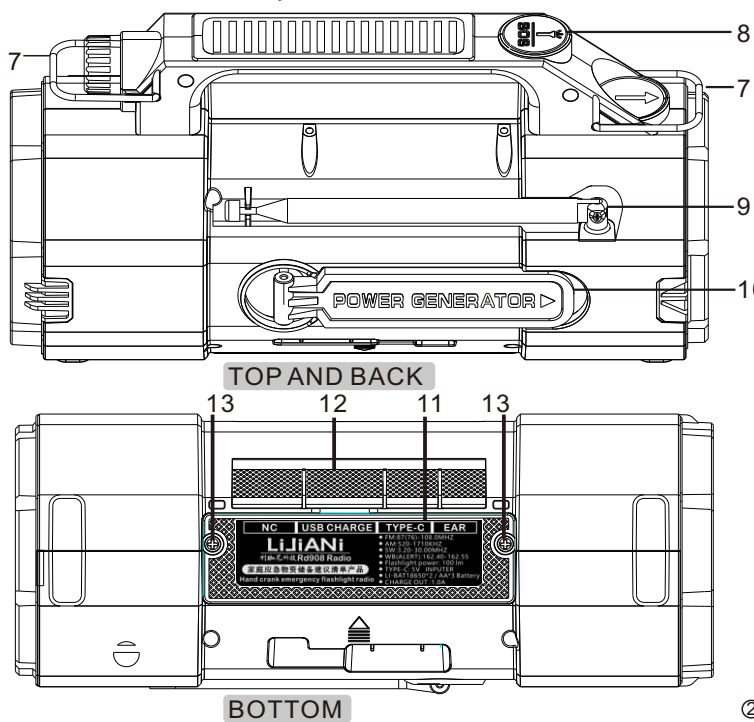

3. LOCK button

Press the LOCK button once. This will lock the tuning dial and the flashlight on/off switch, to prevent accidentally turning on the radio or the flashlight. A lock symbol with the letters RS will be displayed on the screen. A long press of the LOCK button will disable all buttons. A lock symbol with the text ALL and RS will be displayed on the screen. Long press the LOCK key again to enable all buttons.

4. BAND and ATS button

Press the BAND / ATS button repeatedly to switch between different bands. The radio provides FM, WB, SW and AM (MW) coverage. Long press the BAND / ATS button to search and save stations automatically in the present band. FM and AM(MW) have 32 memories each, SW has 60 memories. The saved stations will automatically be saved from 1 to 32 in FM and AM(MW), and from 1 to 60 in SW. Navigate between the saved stations with the M+ and M- buttons, see section 5 below.

5. MEMORY buttons / TIME SET / ALARM SET

After completing an ATS search (see section 4 above), you can manually delete and add stations. To delete frequencies, press the M+ button to find the frequency you want to delete, for example preset 8. Press and hold the DEL button. The characters DEL-PRESET 08 will flash on the screen. Press the DEL button again to confirm deletion. To manually save stations, first tune in to the frequency you would like to save, for example 101.5 MHz. Long press the M+ button. The PRESET symbol will flash on the screen. Navigate to the position where you would like to save the station, for example preset 8, by using the tuning UP or DOWN buttons. Press M+ again to confirm the save.

The memory buttons also serve as the alarm and time set button.

5.1 TO SET THE CLOCK

Long press the M- button when the radio is OFF. Use the tuning dial or up and down buttons to select the correct time. Press the M- button to switch between hour and minute settings, and to select 24-hour or 12-hour clock.

5.2 TO SET THE ALARM

Long press the M+ button when the radio is OFF or in standby mode. Select the time with the tuning dial or the up and down keys. Switch between hours and minutes by pressing the M+ button again. Select the alarm source by pressing the M+ button again. Turn the tuning dial to switch between PON (a radio alarm, the last station listened to) and BUZ (a beeping alarm). To activate and deactivate the alarm, press the alarm button (the M+ button) when the radio is OFF. The alarm symbol will be displayed to indicate that the alarm has been activated, either the beeping alarm or the radio, depending on your selection when you set the alarm.

6. VOLUME buttons

Press these buttons to increase or decrease the volume. Long pressing these buttons will increase or decrease the volume quickly ③

7. CARRY STRAP HANDLES

Flip the carry strap handles (on each side of the radio) upwards to attach the supplied carry strap. The carry strap handle on the side of the tuning dial (that serves as the power switch) helps to prevent turning the radio on accidentally when it is folded down.

8. FLASHLIGHT button

Press the SOS button once to turn on the flashlight. Press it again to turn on a flashing emergency light. Long press the SOS key to turn on an emergency alarm. Beware: the alarm is very loud, do not use indoors. Press the SOS key again to turn off the alarm and flashlight.

9. FM/SW/WB ANTENNA

Extend the antenna to improve SW, FM and WB reception. Swivel the antenna to find the best possible reception. (The MW antenna is inside the radio. Rotate the radio to find the best possible MW reception.)

10. DYNAMO CHARGER

Use the dynamo charger to charge the 18650 or 14500 lithium-ion batteries when there is an emergency situation and you do not have access to power supply for charging.

11. BATTERY COMPARTMENT AND INSTALLING THE BATTERIES

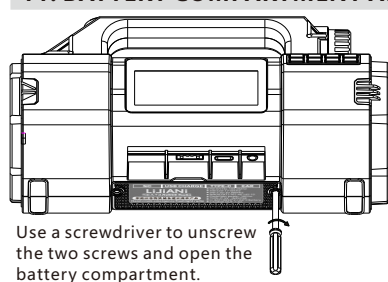

Use a screwdriver to unscrew the two screws and open the battery compartment.

The RD-908 supports various batteries. If you wish to install different batteries, you need to unscrew the two screws (number 13 in the diagram) and carefully slide out the battery compartment. Carefully pry open the black covering plate over the batteries with the screwdriver, from the edge. Pay attention to polarity when installing batteries.

The battery compartment is closed securely with two screws to ensure that no dust or water will enter and damage the batteries or radio. Two lithium-ion 18650 batteries are pre-installed. These are flat-top batteries of 3.7V. Do not use button-top batteries. The radio supports two 18650 batteries for extended battery life, but it will function with just one battery. The 18650 batteries can be recharged through USB type C charging, the dynamo charger or solar charging. Place the radio in sunlight to activate solar charging.

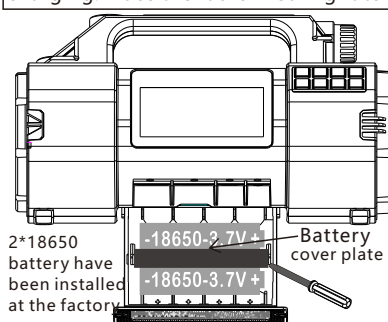

2*18650 battery have been installed at the factory.

You can use three AA batteries instead of the 18650 batteries. You need to remove the 18650 batteries if you wish to use AA batteries. The AA batteries should be 1.5V each, for a total charge of 4.5V. Do not use rechargeable AA batteries. The AA batteries cannot be recharged through USB type C charging, the dynamo charger or solar charging. It is best to use AA batteries only in case of emergency. ④

You can also use a 14500 battery. The 14500 battery is a lithium-ion battery. It is 3.7V, has a button top and is rechargeable. It generally has a capacity of 800mAh and is the same size as an AA battery. Generally, 14500 batteries are used when 18650 batteries are unavailable. It can work by itself or together with the AA batteries. The 14500 battery can be recharged through USB type C charging, the dynamo charger or solar charging.

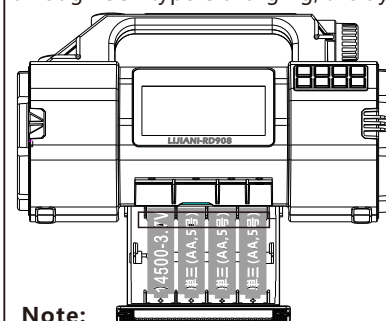

Return the protective cover after installing batteries. Slide the battery compartment back inside and then tighten the screws. Store the screwdriver securely.

Note:

The RD-908 has a battery protection circuit to prevent overcharging and fire. When using 18650 or 14500 lithium-ion batteries, these batteries can provide power to other devices through the USB port behind the protective sleeve on the RD-908.

TIPS FOR BETTER RECEPTION

Use the radio near windows or outdoors, away from radio frequency interference (RFI) caused by computers, motors and other electronics. Do not charge devices such as mobile phones near the radio when listening to SW and MW stations. Chargers cause significant RFI.

COMMON PROBLEMS AND SOLUTIONS

1. Reception is unclear, or you receive very few stations.
 - Using the radio inside concrete buildings; or near fluorescent lights, computers and other equipment that causes electromagnetic interference, will affect the radio signal. Try to move outside, or away from the electromagnetic interference.
 - If you live in an area where you know reception is weak, rather use manual tuning.
 - When listening to AM(MW) radio, rotate the radio to find the best signal. The AM (MW) antenna is inside the radio and will perform best when kept parallel to the ground.
 - When listening to FM/SW/WB, adjust the length, direction and angle of the telescopic antenna to find the best possible signal.
2. The radio does not turn on.
 - Check that the batteries have been installed correctly.
 - Try to install a new battery.
 - Charge the battery for a while and check whether the charging symbol flashes on the screen.
 - If the battery became rusted due to leakage, replace the battery or clean the rust. ⑤

IMPORTANT NOTES

1. It is recommended to use 18650 batteries. The provided 18650 batteries have large capacity and will meet all radio-listening needs. The 14500 and AA batteries should be seen as emergency options.
2. Lijiani RD-908 is waterproof, dustproof and splashproof, with IP64 rating. This makes the radio suitable for outdoor and emergency use.
3. Protective sleeve: The USB charging system (Type C), the headphone plug (stereo on FM) and a USB plug for emergency charging of devices are hidden behind the rubber protective sleeve, to protect the radio from dust and water. Lift up the rubber sleeve to access these functions. (number 12 in the diagram)

TECHNICAL SPECIFICATIONS:

Receiving Range	Sensitivity	Signal-to-Noise Ratio
FM : 87-108 MHz (US)	≤ 3 dB u v	57 dB
FM : 76-108 MHz (JP)	≤ 3 dB u v	57 dB
AM : 520-1710 KHZ	60 dB u v	46 dB
SW : 3.2-30.0 MHz	33 dB u v	
WB : 162.40-162.55 MHz		
Preset Capacity	FM/AM: 32 stations, SW: 60 stations, WB: 0 stations	
Quiescent current	0.08 mA	
Max. current:	2.00 mA	
Flashlight Power:	1.00 W	
Speaker:	Ø66MM-4Ω-5W	
Input Voltage:	TYPE-C: 5V-1.5A	
Output Voltage:	USB: 5V-1.5A	
Battery Specifications:	AA*3/18650*2/14500	
Max. Battery Capacity:	5000 mAh	
Product Size:	3X3.9X7.5 in	

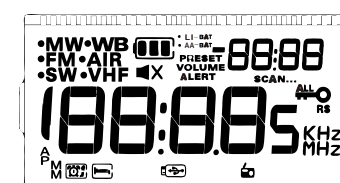

Display Screen

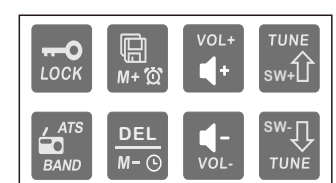

Keyboard、按键

Shenzhen LIJIANI Technology Co.
Email: ZL393688798@foxmail.com

⑥